



# TSW200

v1.2



## HARDWARE

### FRONT VIEW

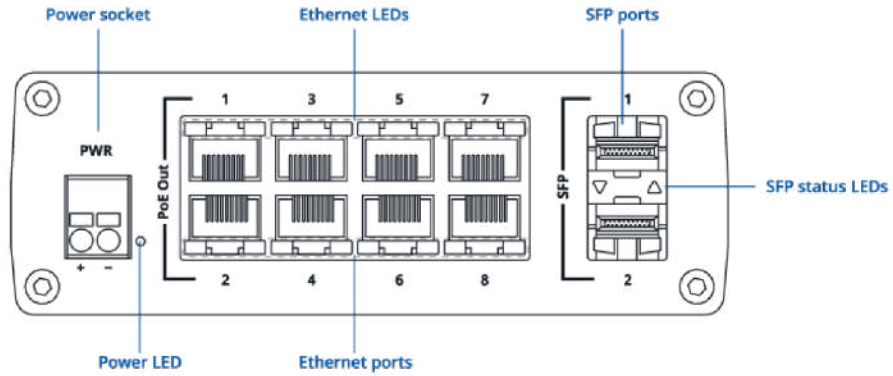

### BACK VIEW

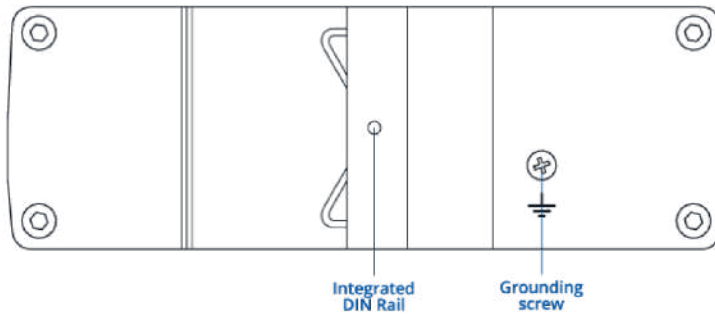

### RJ45 LED MEANING



### POWER SOCKET PINOUT

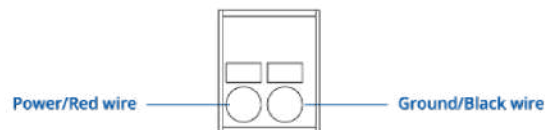

SFP LED MEANING

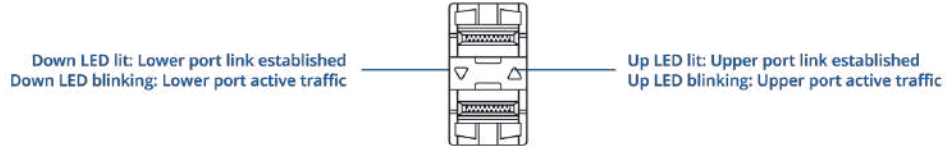

## FEATURES

### Ethernet

<b>ETH</b>	8 x ETH ports, 10/100/1000 Mbps, supports auto MDI/MDIX crossover
<b>Fibre</b>	2 x SFP ports
<b>IEEE 802.3 series standards</b>	802.3i, 802.3u, 802.3ab, 802.3x, 802.3az

### INDUSTRIAL PROTOCOLS

<b>Profinet</b>	Profinet Class A conformance (available with optional order code)
-----------------	---

### POE OUT

<b>PoE ports</b>	Port 1 - 8
<b>PoE standards</b>	802.3af and 802.3at Alternative A (From batch 42) 802.3af and 802.3at Alternative B (From batch 1-41)
<b>PoE Max Power per Port (at PSE)</b>	30 W
<b>Total PoE Power Budget (at PSE)</b>	240 W

### Performance Specifications

<b>Bandwidth (Non-blocking)</b>	20 Gbps
<b>Packer buffer</b>	128 KB
<b>MAC address table size</b>	2K entries
<b>Jumbo frame support</b>	9216 bytes

### Power

<b>Connector</b>	2-pin industrial DC power socket
<b>Input voltage range</b>	7 – 57 VDC
<b>PoE-out input voltage range</b>	44 – 57 VDC
<b>Power consumption</b>	Idle: 1.81 W / Max: 5.5 W / PoE Max: 245.5 W

**Physical Interfaces**

---

<b>Ethernet</b>	8 x RJ45 ports, 10/100/1000 Mbps
<b>Fibre</b>	2 x SFP ports
<b>Status LEDs</b>	1 x Power LED, 16 x ETH status LEDs 2 x SFP status LEDs
<b>Power</b>	1 x 2-pin industrial DC power socket
<b>Other</b>	1 x Grounding screw

**Physical Specification**

---

<b>Casing material</b>	Full aluminum housing
<b>Dimensions (W x H x D)</b>	132 x 44.2 x 95.1 mm
<b>Weight</b>	517 g
<b>Mounting options</b>	Integrated DIN rail bracket; wall mount and flat surface (additional kit needed)

**Operating Environment**

---

<b>Operating temperature</b>	-40 °C to 75 °C
<b>Operating humidity</b>	5% to 95% non-condensing
<b>Ingress Protection Rating</b>	IP30

**Regulatory & Type Approvals**

---

<b>Regulatory</b>	CE, UKCA, CITC, ANRT, FCC, IC, CB
-------------------	-----------------------------------

**EMC Emissions & Immunity**

---

<b>Standards</b>	EN 55032:2015 + A1:2020 EN 55035:2017 + A11:2020 EN IEC 61000-3-2:2019 + A1:2021 EN 61000-3-3:2013 + A1:2019
<b>ESD</b>	EN 61000-4-2:2009
<b>Radiated Immunity</b>	EN IEC 61000-4-3:2020
<b>EFT</b>	EN 61000-4-4:2012
<b>Surge Immunity (AC Mains Power Port)</b>	EN 61000-4-5:2014 + A1:2017
<b>CS</b>	EN 61000-4-6:2014
<b>DIP</b>	EN IEC 61000-4-11:2020

**Safety**

---

**Standards**

IEC 62368-1:2018

EN IEC 62368-1:2020+A11:2020

---

## ORDERING

### STANDARD PACKAGE\*



- TSW200
- QSG (Quick Start Guide)
- Packaging box

\*Standard package contents may differ based on standard order codes.

For more information on all available packaging options – please [contact us](#) directly.

### CLASSIFICATION CODES

**HS Code:** 851762

**HTS:** 8517.62.00

### AVAILABLE VERSIONS

TSW200 *****0	N/A	TSW2000000B0 / Standard package without PSU TSW200000040 / Standard package with EU PSU without connector TSW200000070 / Standard package with US PSU without connector TSW200000090 / Standard package with UK PSU without connector
---------------	-----	--

TSW200 *****1	N/A	TSW200000051 / Standard package without PSU
---------------	-----	---

**Profinet Class A conformance**

## TSW200 SPATIAL MEASUREMENTS

**PHYSICAL SPECIFICATION**

**Device housing (W x H x D)\*** 132 x 44.2 x 95.1 mm

**Box (W x H x D):** 173 x 71 x 148 mm

\*Housing measurements are presented without antenna connectors and screws; for measurements of other device elements look to the sections below.

**TOP VIEW**

The figure below depicts the measurements of device and its components as seen from the top:

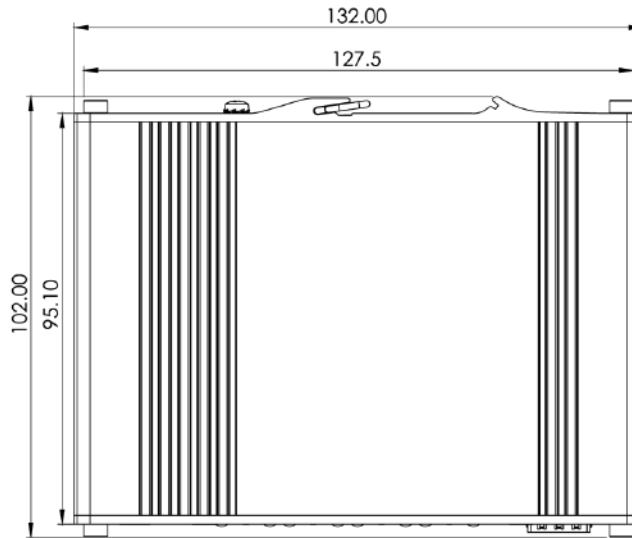

**RIGHT VIEW**

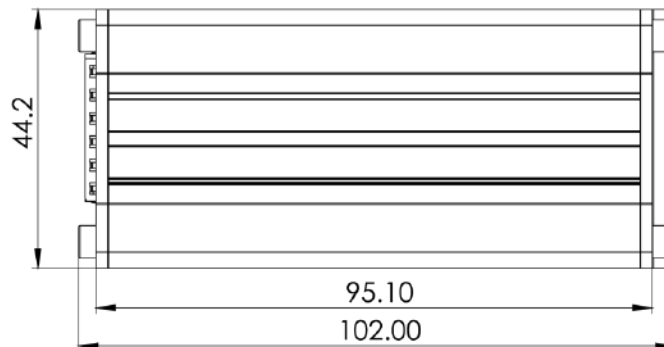
The figure below depicts the measurements of device and its components as seen from the right side:

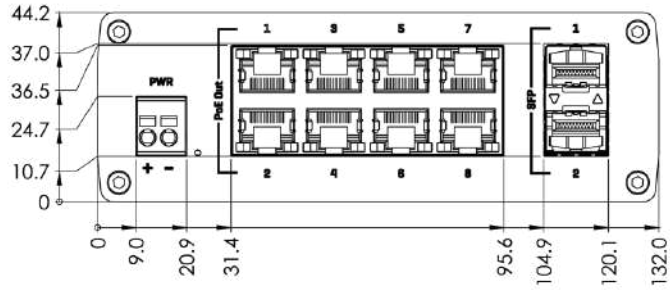

**FRONT VIEW**

The figure below depicts the measurements of device and its components as seen from the front panel side:



**REAR VIEW**

The figure below depicts the measurements of device and its components as seen from the back panel side:

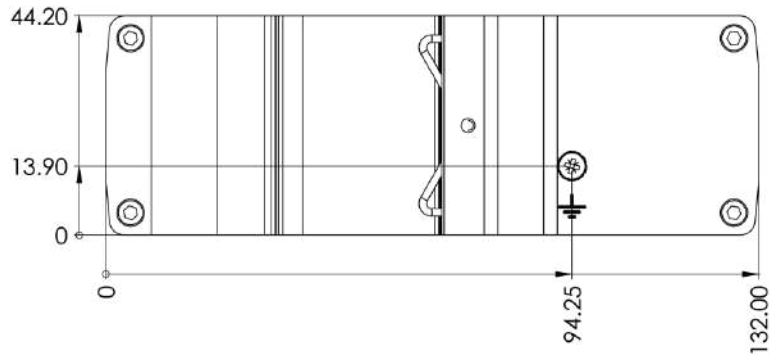

**MOUNTING SPACE REQUIREMENTS**

The figure below depicts an approximation of the device's dimensions when cables and antennas are attached:

