



TRB500



HARDWARE

FRONT VIEW

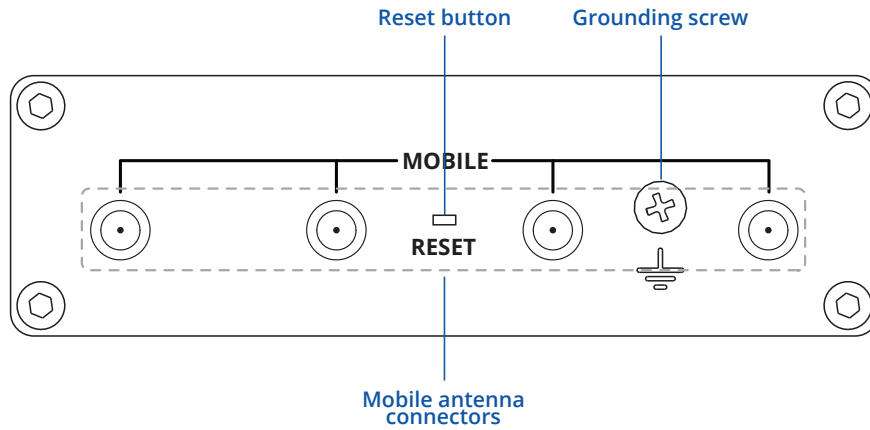

BACK VIEW

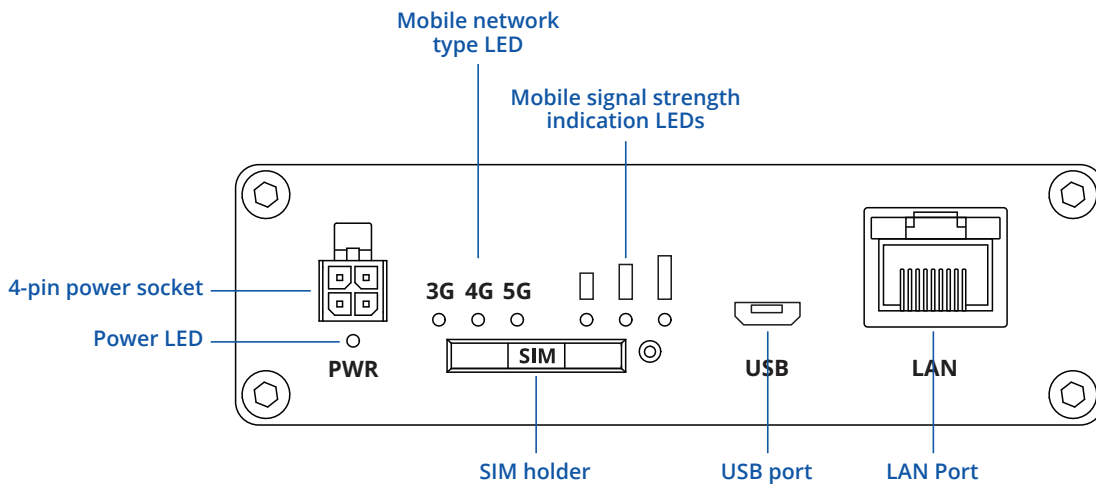

POWER SOCKET PINOUT

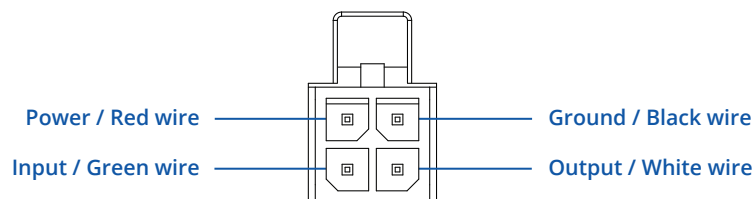

FEATURES

MOBILE

Mobile module	5G Sub-6Ghz SA/NSA 2.1/3.3Gbps DL (4x4 MIMO), 900/600 Mbps UL (2x2); 4G LTE Cat 20 up to 2.0 Gbps DL/ 200M Mbps UL; 3G up to 42 DL/ 5.76 UL Mbps
Status	IMSI, ICCID, operator, operator state, data connection state, network type, CA indicator, bandwidth, connected band, signal strength (RSSI), SINR, RSRP, RSRQ, EC/IO, RSCP, data sent/received, LAC, TAC, cell ID, ARFCN, UARFCN, EARFCN, MCC, and MNC
SMS	SMS status, SMS configuration, send/read SMS via HTTP POST/GET, EMAIL to SMS, SMS to EMAIL, SMS to HTTP, SMS to SMS, scheduled SMS, SMS autoreply, SMPP
USSD	Supports sending and reading Unstructured Supplementary Service Data messages
Black/White list	Operator black/white list (by country or separate operators)
Band management	Band lock, Used band status display
APN	Auto APN
Bridge	Direct connection (bridge) between mobile ISP and device on LAN
Passthrough	Gateway assigns its mobile WAN IP address to another device on LAN
Framed routing	Framed routing: support an IP network behind 5G UE

ETHERNET

Ethernet	1 x ETH port, 10/100/1000 Mbps, supports auto MDI/MDIX crossover
----------	--

NETWORK

Routing	Static routing, Dynamic routing (BGP, OSPF v2, RIP v1/v2, EIGRP, NHRP), Policy based routing
Network protocols	TCP, UDP, IPv4, IPv6, ICMP, NTP, DNS, HTTP, HTTPS, SFTP, FTP, SMTP, SSL/TLS, ARP, VRRP, PPP, PPPoE, UPNP, SSH, DHCP, Telnet, SMPP, SNMP, MQTT, Wake On Lan (WOL)
VoIP passthrough support	H.323 and SIP-alg protocol NAT helpers, allowing proper routing of VoIP packets
Connection monitoring	Ping Reboot, Wget Reboot, Periodic Reboot, LCP and ICMP for link inspection
Firewall	Port forward, traffic rules, custom rules
Firewall status page	View all your Firewall statistics, rules, and rule counters
Ports management	View device ports, enable and disable each of them, turn auto-configuration on or off, change their transmission speed, and so on
Network topology	Visual representation of your network, showing which devices are connected to which other devices
Hotspot	Captive portal (hotspot), internal/external Radius server, Radius MAC authentication, SMS authorisation, internal/external landing page, walled garden, user scripts, URL parameters, user groups, individual user or group limitations, user management, 9 default customisable themes and optionality to upload and download customised hotspot themes
DHCP	Static and dynamic IP allocation, DHCP relay, DHCP server configuration, status, static leases: MAC with wildcards
DDNS	Supported >25 service providers, others can be configured manually
Network backup	Mobile, VRRP, Wired options, each of which can be used as an automatic Failover
SSHFS	Possibility to mount remote file system via SSH protocol

SECURITY

Authentication	Pre-shared key, digital certificates, X.509 certificates, TACACS+, Radius, IP & login attempts block, time-based login blocking, built-in random password generator
Firewall	Pre-configured firewall rules can be enabled via WebUI, unlimited firewall configuration via CLI; DMZ; NAT; NAT-T
Attack prevention	DDOS prevention (SYN flood protection, SSH attack prevention, HTTP/HTTPS attack prevention), port scan prevention (SYN-FIN, SYN-RST, X-mas, NULL flags, FIN scan attacks)
VLAN	Port and tag-based VLAN separation
Mobile quota control	Mobile data limit, customizable period, start time, warning limit, phone number
WEB filter	Blacklist for blocking out unwanted websites, Whitelist for specifying allowed sites only
Access control	Flexible access control of SSH, Web interface, CLI and Telnet

VPN

OpenVPN	Multiple clients and a server can run simultaneously, 27 encryption methods
OpenVPN Encryption	DES-CBC 64, RC2-CBC 128, DES-EDE-CBC 128, DES-EDE3-CBC 192, DESX-CBC 192, BF-CBC 128, RC2-40-CBC 40, CAST5-CBC 128, RC2-64-CBC 64, AES-128-CBC 128, AES-128-CFB 128, AES-128-CFB1 128, AES-128-CFB8 128, AES-128-OFB 128, AES-128-GCM 128, AES-192-CFB 192, AES-192-CFB1 192, AES-192-CFB8 192, AES-192-OFB 192, AES-192-CBC 192, AES-192-GCM 192, AES-256-GCM 256, AES-256-CFB 256, AES-256-CFB1 256, AES-256-CFB8 256, AES-256-OFB 256, AES-256-CBC 256
IPsec	IKEv1, IKEv2, with 14 encryption methods for IPsec (3DES, DES, AES128, AES192, AES256, AES128GCM8, AES192GCM8, AES256GCM8, AES128GCM12, AES192GCM12, AES256GCM12, AES128GCM16, AES192GCM16, AES256GCM16)
GRE	GRE tunnel, GRE tunnel over IPsec support
PPTP, L2TP	Client/Server instances can run simultaneously, L2TPv3, L2TP over IPsec support
Stunnel	Proxy designed to add TLS encryption functionality to existing clients and servers without any changes in the program's code
DMVPN	Method of building scalable IPsec VPNs
SSTP	SSTP client instance support
ZeroTier	ZeroTier VPN client support
WireGuard	WireGuard VPN client and server support
Tinc	Tinc offers encryption, authentication and compression in it's tunnels. Client and server support

OPC UA

Supported modes	Client, Server
Supported connection types	TCP

MODBUS

Supported modes	Server, Client
Supported connection types	TCP
Custom registers	MODBUS TCP custom register block requests, which read/write to a file inside the router, and can be used to extend MODBUS TCP Client functionality
Supported data formats	8-bit: INT, UINT; 16-bit: INT, UINT (MSB or LSB first); 32-bit: float, INT, UINT (ABCD (big-endian), DCBA (little-endian), CDAB, BADC), HEX, ASCII

DATA TO SERVER

Protocol	HTTP(S), MQTT, Azure MQTT, Kinesis
Data to server	Extract parameters from multiple sources and different protocols, and send them all to a single server

MQTT GATEWAY

Modbus MQTT Gateway	Allows sending commands and receiving data from MODBUS Server through MQTT broker
---------------------	---

DNP3

Supported modes	Station, Outstation
Supported connection	TCP

DLMS

DLMS Support	DLMS - standard protocol for utility meter data exchange
Supported modes	Client
Supported connection types	TCP

DLMS

Teltonika Networks Web API (beta) support	Expand your device's possibilities by using a set of configurable API endpoints to retrieve or change data. For more information, please refer to this documentation: https://developers.teltonika-networks.com
---	---

MONITORING & MANAGEMENT

WEB UI	HTTP/HTTPS, status, configuration, FW update, CLI, troubleshoot, multiple event log servers, firmware update availability notifications, event log, system log, kernel log, Internet status
FOTA	Firmware update from server, automatic notification
SSH	SSH (v1, v2)
SMS	SMS status, SMS configuration, send/read SMS via HTTP POST/GET
Call	Reboot, Status, Mobile data on/off, Output on/off, answer/hang-up with a timer
TR-069	OpenACS, EasyCwmp, ACSLite, tGem, LibreACS, GenieACS, FreeACS, LibCWMP, Friendly tech, AVSystem
MQTT	MQTT Broker, MQTT publisher
SNMP	SNMP (v1, v2, v3), SNMP Trap
JSON-RPC	Management API over HTTP/HTTPS
RMS	Teltonika Remote Management System (RMS)

IoT PLATFORMS

Clouds of things	Allows monitoring of: Device data, Mobile data, Network info, Availability
ThingWorx	Allows monitoring of: WAN Type, WAN IP, Mobile Operator Name, Mobile Signal Strength, Mobile Network Type
Cumulocity	Allows monitoring of: Device Model, Revision and Serial Number, WAN Type and IP, Mobile Cell ID, ICCID, IMEI, Connection Type, Operator, Signal Strength
Azure IoT Hub	Can send device IP, Number of bytes send/received, Temperature, PIN count to Azure IoT Hub server, Mobile connection state, Network link state, IMEI, ICCID, Model, Manufacturer, Serial, Revision, IMSI, SIM State, PIN state, GSM signal, WCDMA RSCP, WCDMA EC/IO, LTE RSRP, LTE SINR, LTE RSRQ, CELL ID, Operator, Operator number, Connection type

SYSTEM CHARACTERISTICS

CPU	Single core ARM Cortex A7, 1.5 GHz
RAM	256 MB (128 MB available for userspace)
FLASH storage	512 MB (200 MB available for userspace)

FIRMWARE / CONFIGURATION

WEB UI	Update FW from file, check FW on server, configuration profiles, configuration backup
FOTA	Update FW
RMS	Update FW/configuration for multiple devices at once
Keep settings	Update FW without losing current configuration
Factory settings reset	A full factory reset restores all system settings, including the IP address, PIN, and user data to the default manufacturer's configuration

FIRMWARE CUSTOMISATION

Operating system	RutOS (OpenWrt based Linux OS)
Supported languages	Busybox shell, Lua, C, C++, and Python, Java in Package manager
Development tools	SDK package with build environment provided
GPL customization	You can create your own custom, branded firmware and web page application by changing colours, logos, and other elements in our firmware to fit your or your clients' needs

INPUT/OUTPUT

Configurable I/O	1 x Digital Input, 0 - 6 V detected as logic low, 8 - 30 V detected as logic high
Output control	1 x Digital Output, Open collector output, max output 30 V, 300 mA
Events	Email, RMS, SMS
I/O juggler	Allows to set certain I/O conditions to initiate event

POWER

Connector	4-pin industrial DC power socket
Input voltage range	9 – 30 VDC, reverse polarity protection, surge protection +/- 1 kV 50 µs max
Power consumption	Idle: < 3 W, Max < 6 W

PHYSICAL INTERFACES

Ethernet	1 x RJ45 port, 10/100/1000 Mbps
I/O's	2 x Configurable I/O pins on 4-pin power connector
Status LEDs	3 x connection type status LEDs, 3 x connection strength LEDs, 2 x ETH status LEDs, 1 x Power LED
SIM	1 x SIM slot (Mini SIM – 2FF), 1.8 V/3 V
Power	1 x 4-pin power connector
Antennas	4 x SMA for Mobile
USB	1 x Virtual network interface via micro USB
Reset	Reboot/User default reset/Factory reset button

PHYSICAL SPECIFICATION

Casing material	Aluminium housing
Dimensions (W x H x D)	100 x 30 x 93,4 mm
Weight	241g
Mounting options	DIN rail, wall mount, flat surface (all require additional kit)

OPERATING ENVIRONMENT

Operating temperature	-40 °C to 75 °C
Operating humidity	10 % to 90 % non-condensing
Ingress Protection Rating	IP30

REGULATORY & TYPE APPROVALS

Regulatory	CE, UKCA, RCM, CB, NBTC, RoHS, REACH
------------	--------------------------------------

EMC EMISSIONS & IMMUNITY

Standards	EN 55032:2015 + A11:2020 + A1:2020 EN 55035:2017 + A11:2020 EN IEC 61000-3-2: 2019 + A1:2021 EN 61000-3-3: 2013 + A1:2019 + A2:2021 EN 301 489-1 V2.2.3 EN 301 489-52 V1.2.1
ESD	EN 61000-4-2:2009
Radiated Immunity	EN IEC 61000-4-3:2020
EFT	EN 61000-4-4:2012
Surge Immunity (AC Mains Power Port)	EN 61000-4-5:2014 + A1:2017
CS	EN 61000-4-6:2014
DIP	EN 61000-4-11:2020

RF

Standards	EN 301 908-1 V13.1.1 EN 301 908-2 V13.1.1 EN 301 908-13 V13.1.1 EN 301 908-25 V15.1.1_15.0.6
-----------	---

SAFETY

Standards	CE: EN IEC 62368-1:2020 + A11:2020, EN 62311:2020 RCM: AS/NZS 62368.1:2022 CB: IEC 62368-1:2018
-----------	---

WHAT'S IN THE BOX?

STANDARD PACKAGE CONTAINS*

- TRB500 Gateway
- 9 W PSU
- 4x Mobile antennas (swivel, SMA male)
- Micro-USB cable (0.8 m)
- Ethernet cable
- SIM Adapter kit
- QSG (Quick Start Guide)
- Packaging box



TRB500 GATEWAY



9 W PSU



4 X MOBILE ANTENNAS (SWIVEL, SMA MALE)



MICRO-USB CABLE (0.8 M)

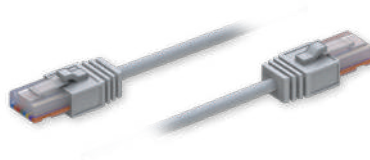

ETHERNET CABLE



SIM ADAPTER KIT

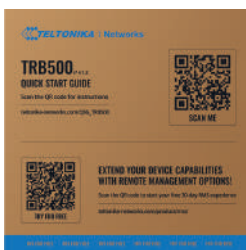

QSG

* For all standard order codes standard package contents are the same, except for PSU.

STANDARD ORDER CODES

PRODUCT CODE	HS CODE	HTS CODE	PACKAGE CONTAINS
TRB500 000000	851762	8517.62.00	Standard Package with EU PSU

For more information on all available packaging options – please contact us directly.

AVAILABLE VERSIONS

PRODUCT CODE	REGION (OPERATOR)	FREQUENCY
TRB500 0*****	Europe ¹ , the Middle East, Africa, Oceania, Brazil	<ul style="list-style-type: none"> • 5G NR NSA: n1, n3, n5, n7, n8, n20, n38, n40, n41, n77, n78 • 5G NR SA: n1, n3, n5, n7, n8, n20, n38, n40, n41, n77, n78 • 4G (LTE-FDD): B1, B3, B5, B7, B8, B20, B32 • 4G (LTE-TDD): B38, B40, B41, B42, B43 • 3G: B1, B8
TRB500 000601	Thailand	<ul style="list-style-type: none"> • 5G NR NSA: n7, n40, n77, n78 • 5G NR SA: n1, n3, n5, n7, n8, n20, n38, n40, n41, n77, n78 • 4G (LTE-FDD): B1, B3, B5, B7, B8, B20, B32 • 4G (LTE-TDD): B38, B40, B41, B42, B43 • 3G: B1, B8

The price and lead-times for region (operator) specific versions may vary. For more information please contact us.

1 - Regional availability - excluding Russia & Belarus.

TRB500 SPATIAL MEASUREMENTS & WEIGHT

MAIN MEASUREMENTS

W x H x D dimensions for TRB500:

Device housing*: 100 x 30 x 93.4 mm

Box: 173 x 71 x 148 mm

*Housing measurements are presented without antenna connectors and screws; for measurements of other device elements look to the sections below.

TOP VIEW

The figure below depicts the measurements of TRB500 and its components as seen from the top:

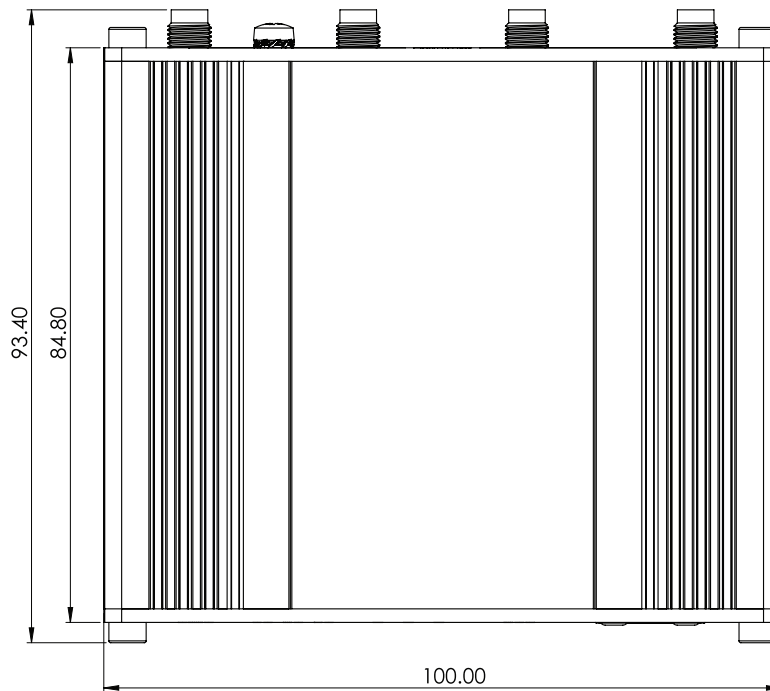

RIGHT VIEW

The figure below depicts the measurements of TRB500 and its components as seen from the right side:

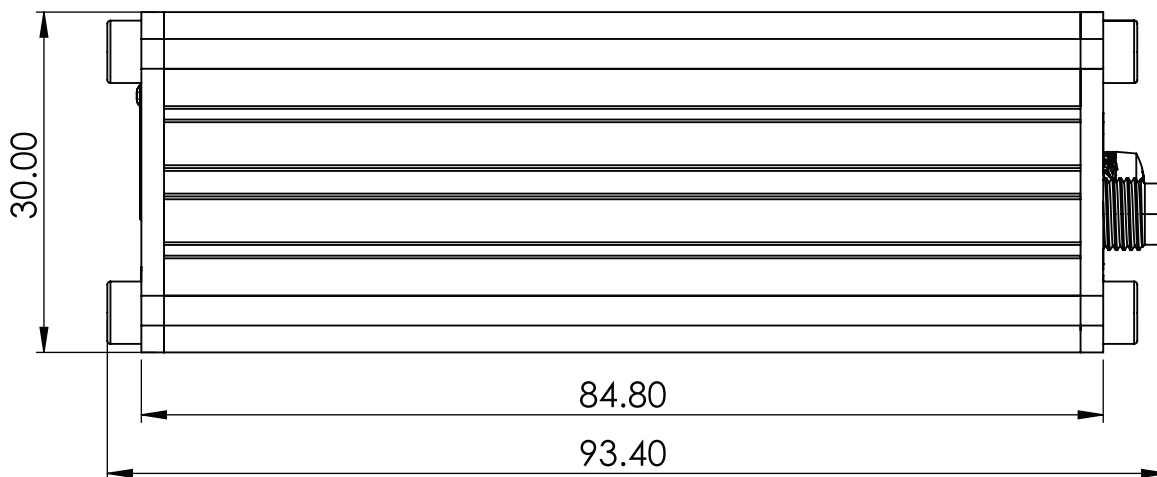

FRONT VIEW

The figure below depicts the measurements of TRB500 and its components as seen from the front panel side:

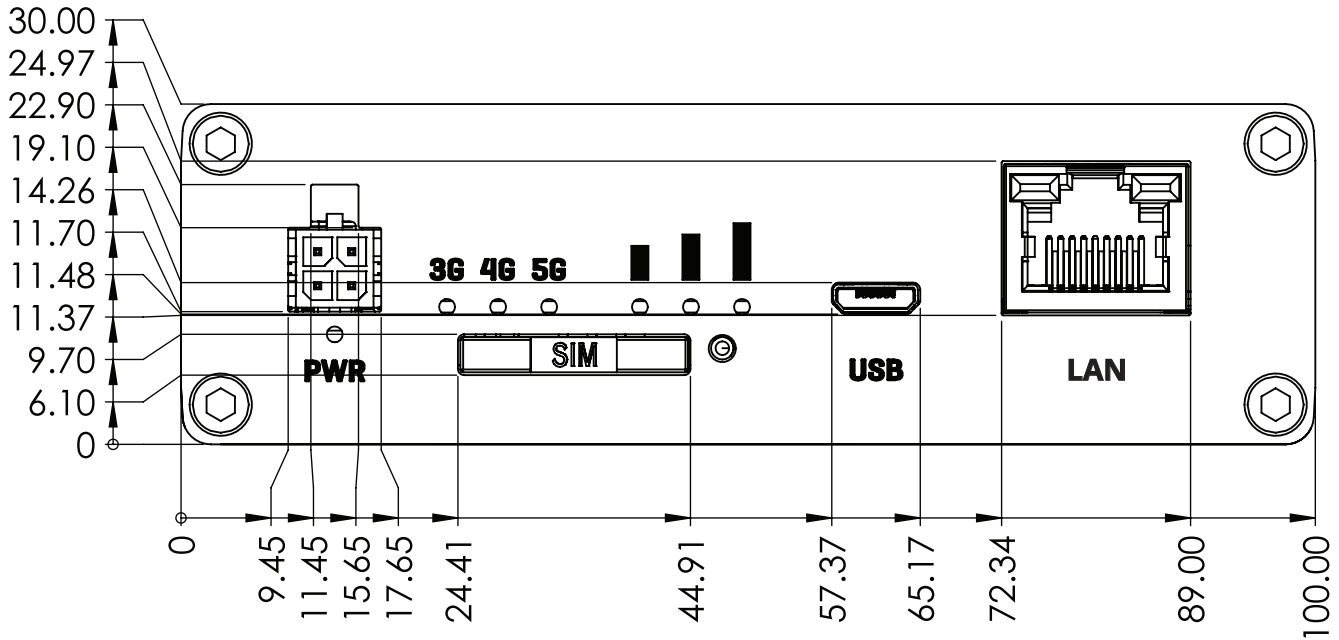

REAR VIEW

The figure below depicts the measurements of TRB500 and its components as seen from the back panel side:

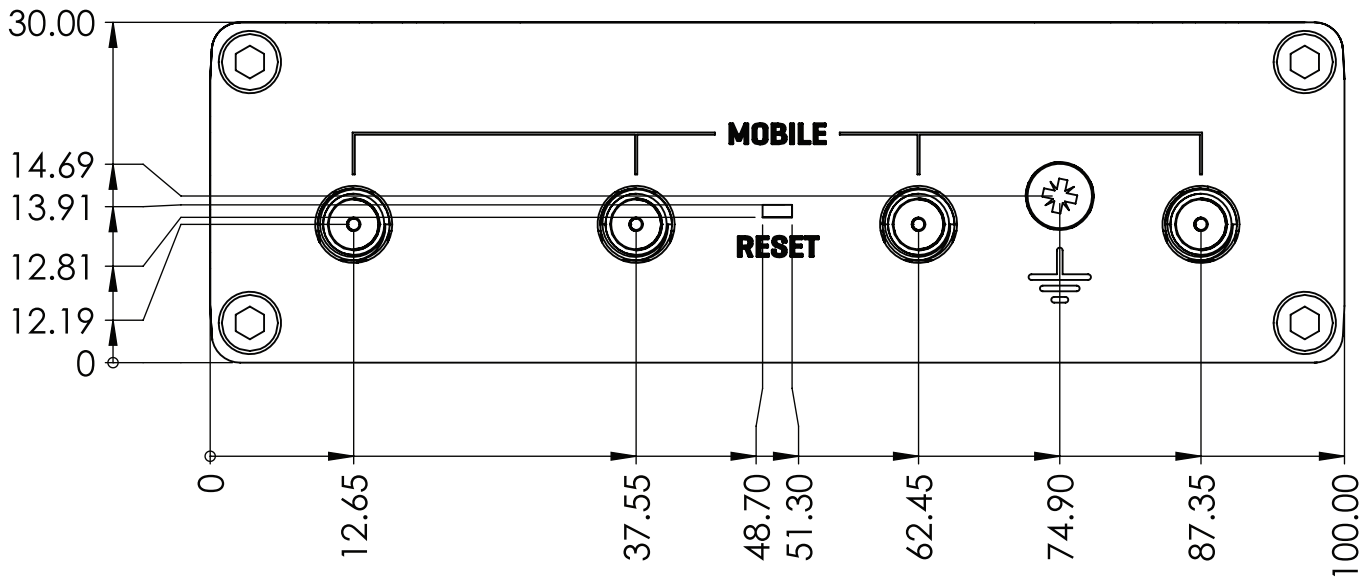

MOUNTING SPACE REQUIREMENTS

The figure below depicts an approximation of the device's dimensions when cables and antennas are attached:

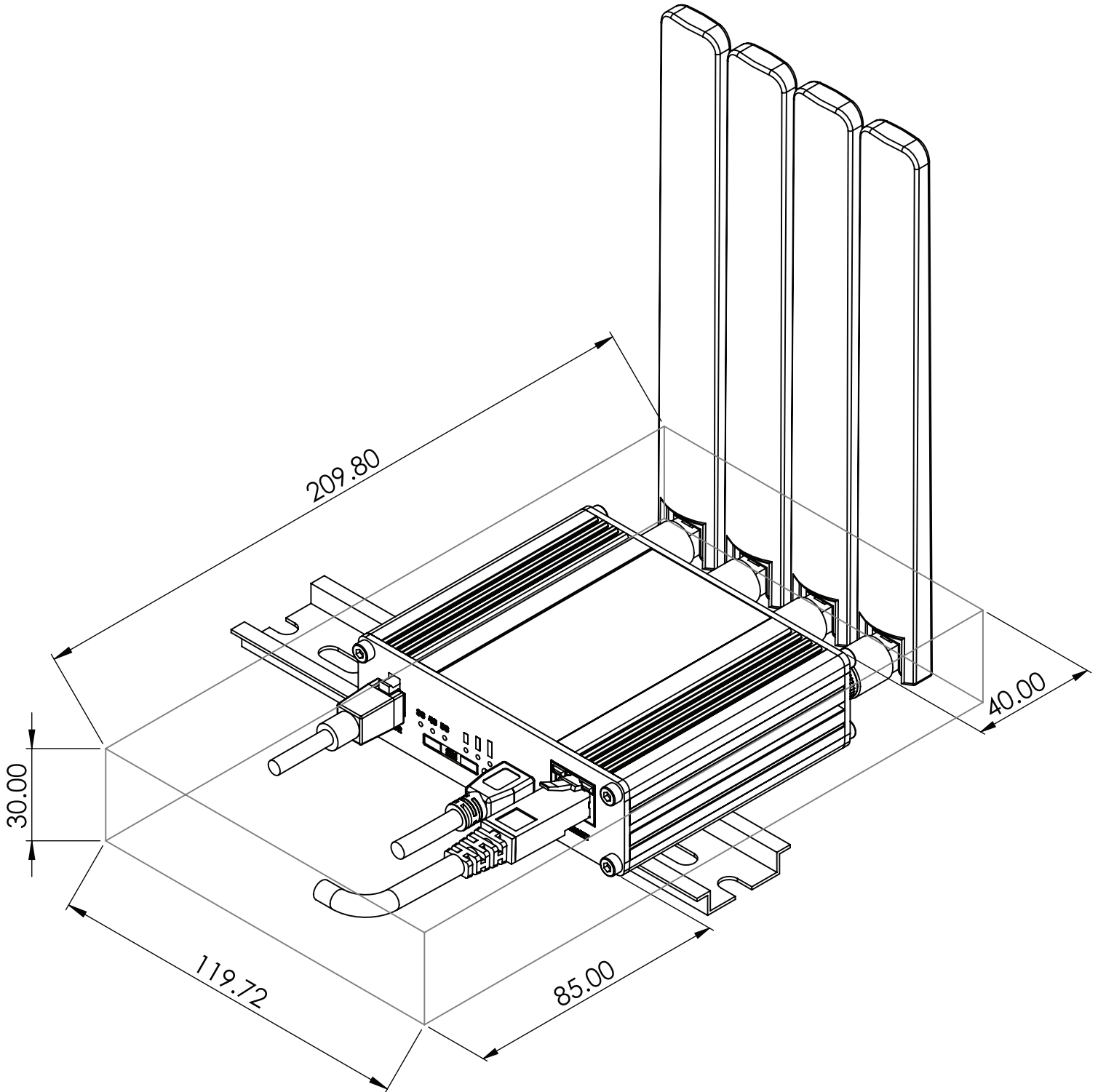

DIN RAIL

The scheme below depicts protrusion measurements of an attached DIN Rail:

